

UML

Klassendiagramme

Klasse

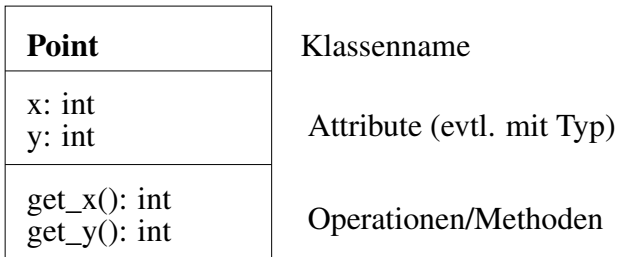

Generalisierung/Spezialisierung

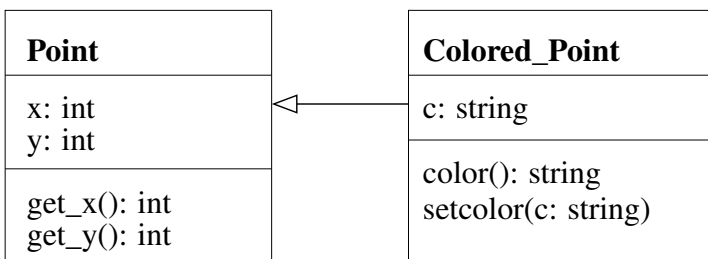

Assoziation

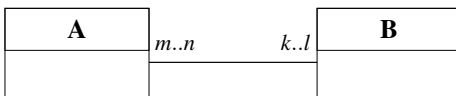

Aggregation

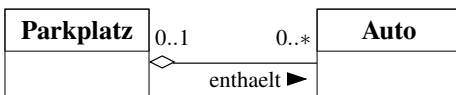

Komposition

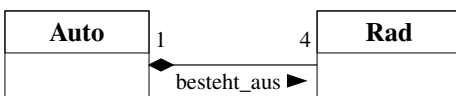

Zustandsdiagramme

Startzustand

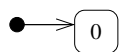

Endzustand

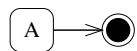

Transition

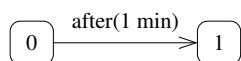

Ereignis/Bedingung/Effekt

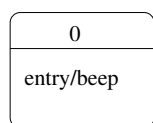

Regionen und zusammengesetzte Zustände

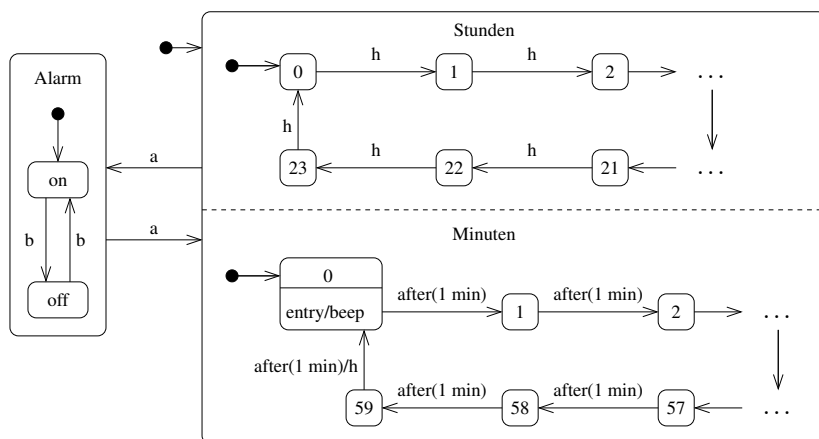

Historien und Eintrittsmöglichkeiten

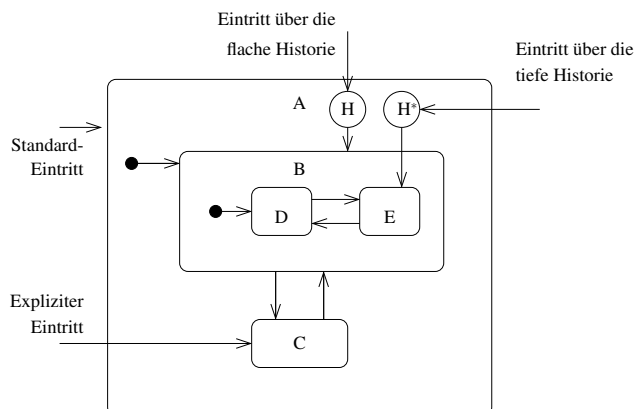

Aktivitätsdiagramm (und Vergleich mit Petri-Netzen)

Aktionen und Objektknoten

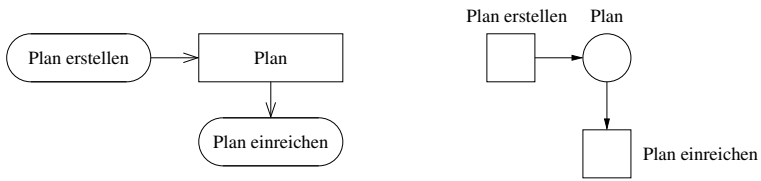

Startknoten



Endknoten



Entscheidungsknoten

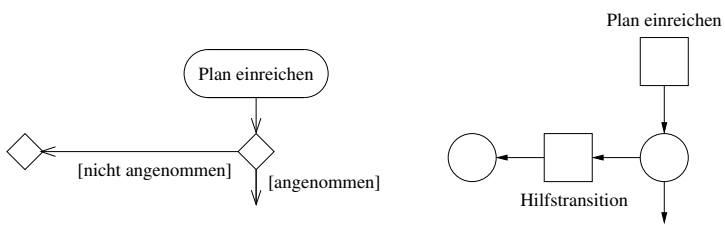

Verbindungsknoten



Gabelung

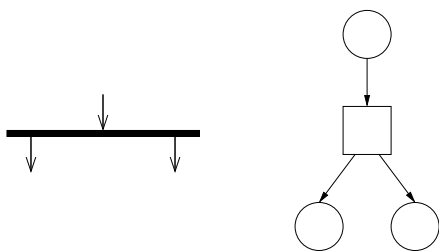

Vereinigung

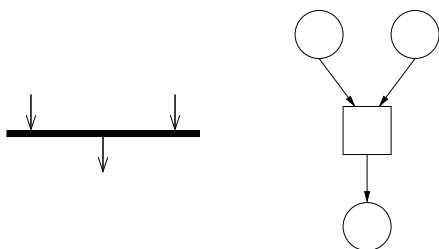

Sequenzdiagramme

Kommunikationspartner

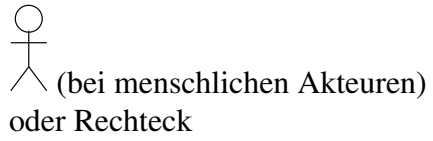

Ausführungsbalken



Synchrone Nachrichten



Asynchrone Nachrichten

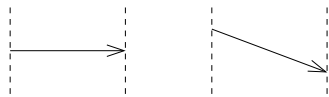

Nachricht an sich selbst

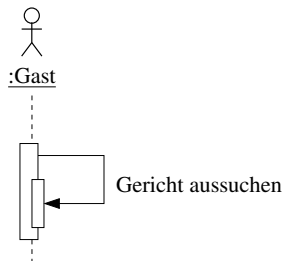

Antworten

